

Article number: 204141812AKNI

Description: E+G Stainless steel safety indexing plungers
GN 414.1-8-12-AK with safety mechanism, without rest position, with lock nut

Measures

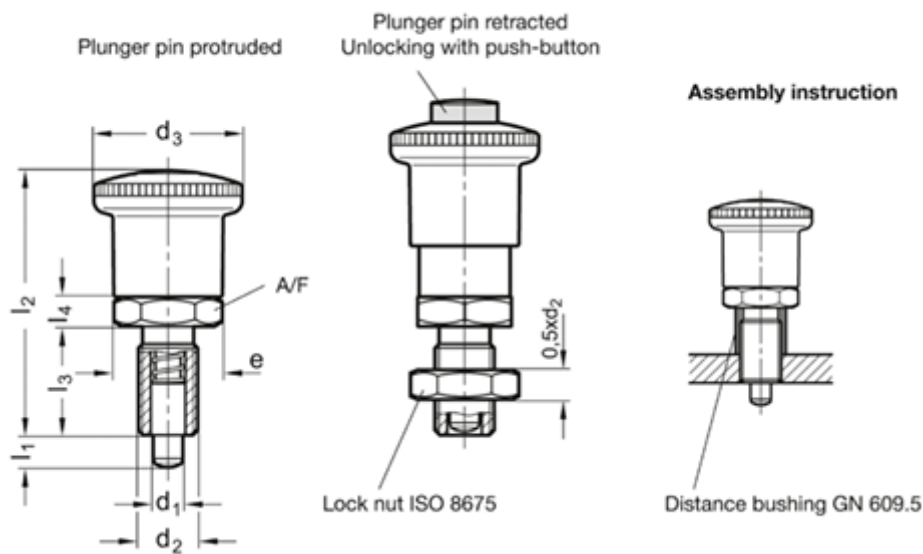

A/F	= 28	l2 ?	= 59.5
d1 Pin -0.02/-0.04 Bore H7	= 8	Weight in (g)	= 80
d2	= M 16 x 1.5		
d3	= 30		
e	= 21.9		
l3	= 26		
l4	= 8		
l1 min.	= 12		